

OPERATION MANUAL

AICHI TURBINE GAS METER

TBX30, TBX100, TBX100F, TBX150F

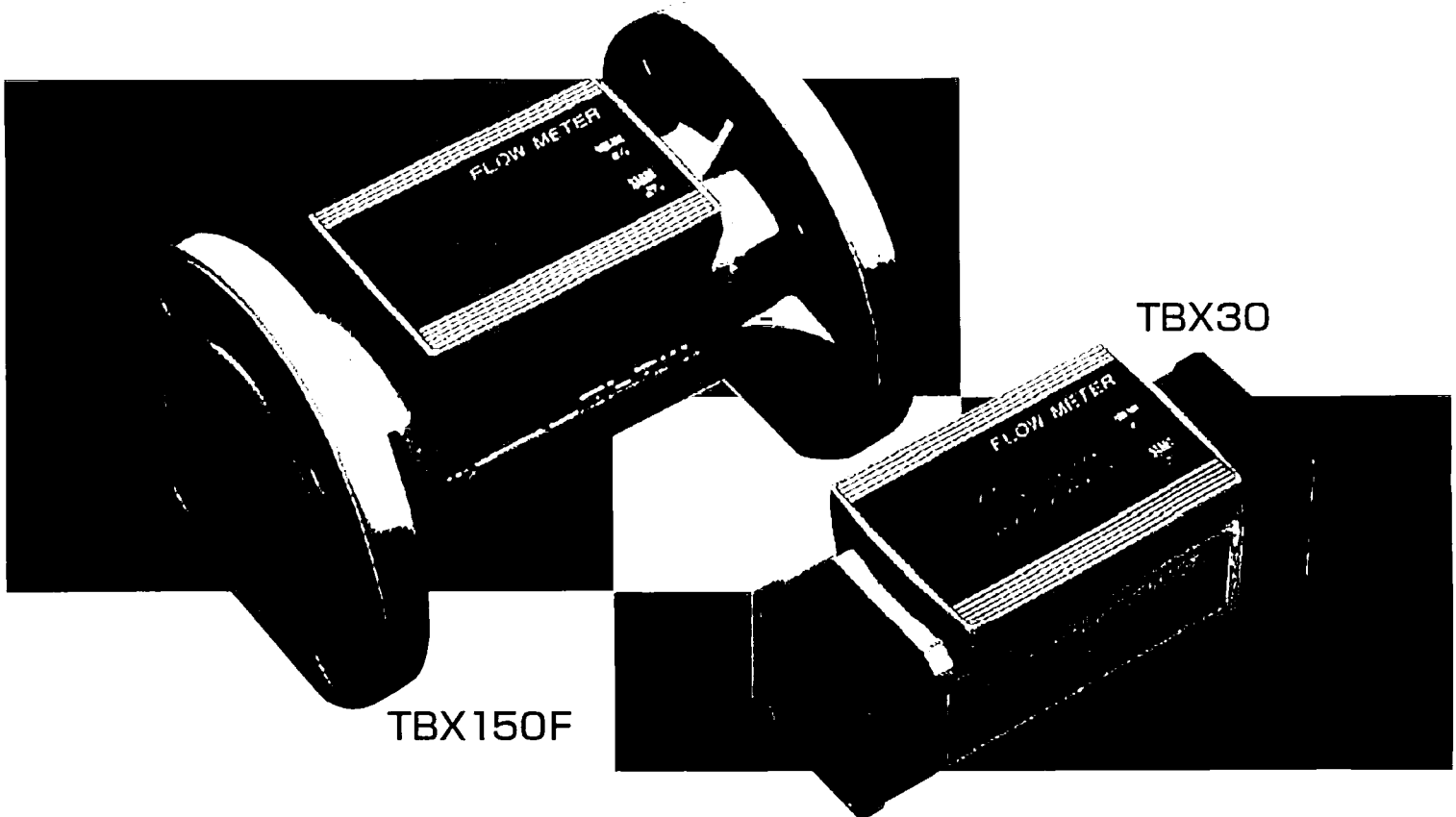

Thank you very much for your procurement of
Aichi Turbine Gas Meter.
To use the meter correctly, please be sure to read
this operation manual carefully
before installation.

CONTENTS



1. FOR YOUR CORRECT AND SAFE USE	1P	9. DIMENSIONS	11P
2. SPECIAL CAUTIONS	2P	10. SERVICE LIFE	11P
3. FOR YOUR CORRECT USE	3~4P	11. APPLICATION EXAMPLES	12P
4. INSTALLATION AND PIPING PROCEDURE ...	5~6P	12. OUTPUT SIGNAL	12P
5. NAMES AND FUNCTION OF DISPLAY ...	7~8P	13. SIGNAL WIRE UNIT (OPTION)	13P
6. STARTING OPERATION PROCEDURE	9P	14. REMOTE DISPLAY / COUNTER (OPTION) ...	14P
7. INSPECTION PROCEDURE	9P	15. WARRANTY	15P
8. SPECIFICATIONS	10P		







1. FOR YOUR CORRECT AND SAFE USE

This operation manual uses various picture signs for you to use the Turbine Gas Meter correctly, to prevent injuries on yourself and other people, and also to prevent damage to properties.

The signs and their meanings are as follows.

Please proceed to instructions after fully understanding the signs.

SIGN	MEANING	PAGE
 DANGER	If you operate the product incorrectly ignoring this sign, you may incur imminent danger of death or serious injuries.	None
 WARNING	If you operate the product incorrectly ignoring this sign, you may incur danger of death or serious injuries.	None
 CAUTION	If you operate the product incorrectly ignoring this sign, you may incur injuries or material damage.	2

Each picture sign has the following meaning						
	Caution In General	Do Not Touch	Prohibition In General	Do Not Disassemble	No Fire	Do Without Fail
Page	4·8·9·11	—	2·4	2	—	2·3·4·8

2. SPECIAL CAUTIONS

CAUTION

1. Do not install the meter in any dangerous place



Prohibition

The electric circuit of the meter is not explosion proof structure.

2. Do not use the meter for measuring any of corrosive gases or following gases



Prohibition

Measuring any of corrosive gases or following gases with the meter will cause corrosion of its parts and will be the cause of gas leakage. Also, the meter cannot measure these gases correctly.

Poisonous gas	Chlorine, Hydrogen cyanide, Nitrogen dioxide, Fluorine
	Hydrogen chloride, Boron trifluoride, Boron dioxide
	Sulfur dioxide, Hydrogen fluoride, Sulfur sulfide
Others	Ammonia, Chlorine dioxide, Oxygen, Hydrogen, Helium

Deterioration of the meter performance or damage on the meter may be caused by measuring gases having certain physical prosperities. Please check us in case of measuring special gas.

3. Do not give the meter a shock



Prohibition

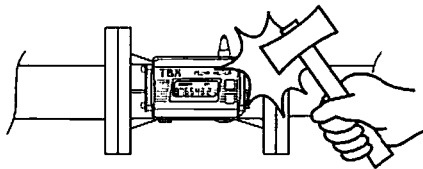

The meter is a precision measuring instrument. Do not give the meter a strong shock. Also, do not hit the meter with a thing. They will be the cause of gas leakage and/or damage.

4. Do not disassemble the meter



Do Not Disassemble

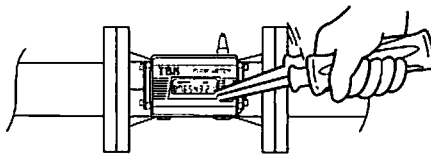

The meter is a precision measuring instrument.
Do not disassemble the meter.
It will be the cause of gas leakage.

5. After installation of the meter, execute an airtight test of the portion including pipes, etc., in the upstream and the downstream of the meter



Do Without Fail

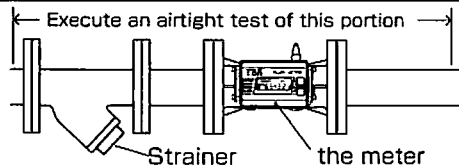

Please check there is no leakage at pressure of $1.1 \times$ Maximum Working Pressure.

6. Disposal of the used meter



Do Without Fail

For our collection of the waste lithium battery, please send the meter back to us after finishing its use.
Or, please disposal the lithium battery as industrial waste after complete discharge of its electricity.

3. FOR YOUR CORRECT USE

1. Check the specifications on the name plate are suitable to your working conditions



Do Without Fail

Model	TBX150F-L
Range	12.5~150 m ³ /h
Max. Pressure	100 kPa
Temperature	-10~60 °C
Standard point	actual
Output A[B]	0.10 m ³ /P [470 $\frac{cm^3}{P}$]
Date	'97-05
Serial No.	0000003

Aichi teki denki co., ltd.

- Model
- Flow range
- Maximum working pressure
- Working temperature range
- actual
- Unit pulse
- High-density pulse
- Year and month manufactured
- Serial number

2. Make the gas flow direction be complied with the arrow mark on the meter body



Do Without Fail

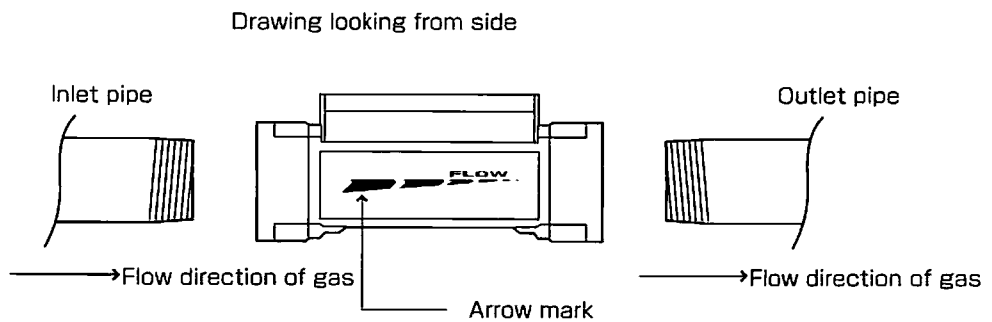

3. Install a strainer at the upstream of the meter



Do Without Fail

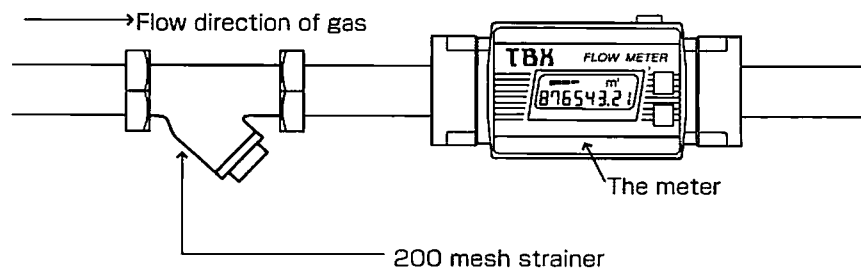

4. Do not install the meter in a place where oil mist and/or dust powder, etc., waft

- ① Using the meter with LP Gas (Liquid Petroleum Gas) produced by a vaporizer may cause abnormality of the meter's turning parts because of oil mist (adhesive substance due to re-liquefaction) in pipes. And as the result, the meter may be impossible to measure correctly.

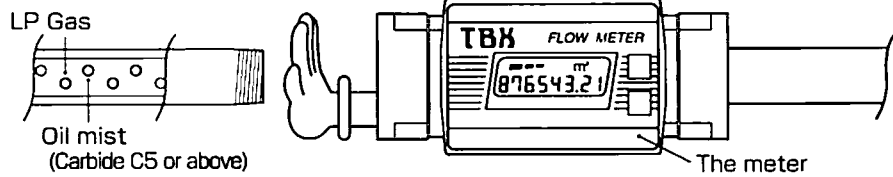

- ② Using the meter for dry gas (13A Gas, etc.) may cause abnormality of the meter's turning parts because of dust powder (Powdery foreign substance) in pipes. And as the result, the meter may be impossible to measure correctly.

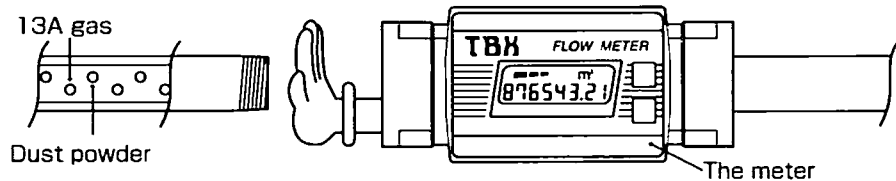

5. Do not tighten the flange nuts excessively at the time of the meter installation

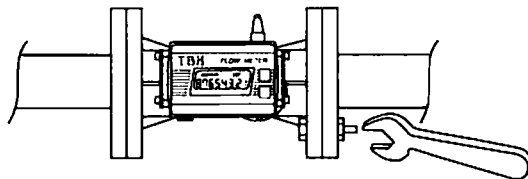

After lightly tightening all the nuts, tighten them diagonally with equal power. (For TBX100F and TBX150F)

6. To connect the meter flanges to companion flanges, adjust the center of the meter body to the same of companion pipes

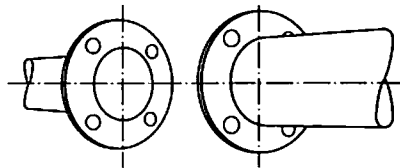

Avoid eccentricity of the center of the meter body from the same of companion pipes. And, avoid inclining and distortion of the flanges. Also, do not give excessive stress load to the meter body. (For TBX100F and TBX150F)

7. To install the meter in new piping, execute dust purge to remove foreign matters in pipes before the installation

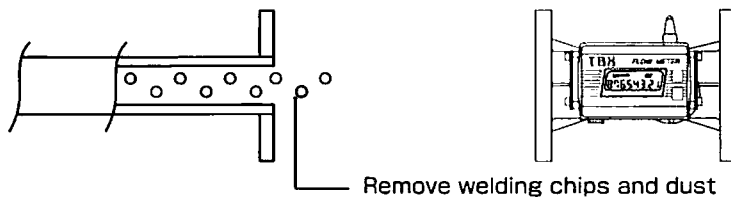

4. INSTALLATION AND PIPING PROCEDURE

1. The Turbine Gas Meter is of indoor type. Install it in a place not exposed to rainwater.
2. The meter can be installed both horizontally and vertically. Install it in between straight pipes.
3. Do not install the meter in a place where there is possibility of remaining of liquid such as oil, water, etc.
4. Install a strainer (200 mesh) at the upstream of the meter (See Page3).
5. Do not install the meter in a place where oil mist and/or dust powder, etc., waft. It may cause abnormality of the meter's turning parts and the meter may be impossible to measure correctly as the result (See Page4) .
6. Do not install the meter to a device that generates oscillation, such as a gas engine, as the meter cannot measure correctly.
7. Provide at least 10D (10×Meter's Nominal Diameter) straight pipes at the upstream and the downstream of the meter.
8. During installation and piping, make sure not to let foreign materials such as weld chips, dirt, waste sealant, etc. into the Turbine Gas Meter.
9. Do not install in a place where a shock pressure is given to the meter.
10. Keep the meter and its output signal wire apart at least 1~2m from any of control instruments (ex: an electromagnetic valve), noise sources (ex: a power cable), etc.
11. Direction of the display can be selected according to your piping.

① Thread Connection Type (Example: TBX30)

(1) Installation

To install the meter, fix the connection units and screw in male threaded tapered pipes to the both sides of the meter.

(2) Maintenance

- ① By detaching the bolts (8 bolts) at the outer side of the connection units, the meter body can be drawn out in the direction perpendicular to the pipes.
- ② After replacing the O-rings with new ones to which grease has been applied beforehand, install the meter body to the connection units. And, tighten the bolts.

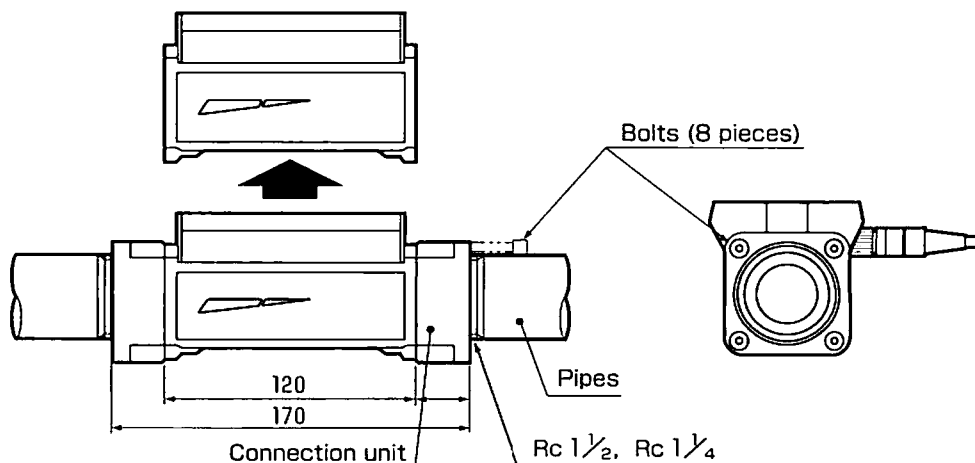

Flange Connection Type (Example: TBX100F)

The display of the Turbine Gas Meter can be turned round so as to match it to the direction of a gas flow. Also, the display can be removed from the meter body to use it as the remote display. To turn round the display,

- ① Remove the hexagonal socket bolts on the both sides of display.
- ② A. Fix the mounting plate on the wall (With accessory screws).
 - B. Turn the display 180°.
 - C. Turn the mounting plate 90° and fix it (With accessory screws).
- ③ Fix the counter.

The display can be placed at an angle of maximum 10° (approx.).

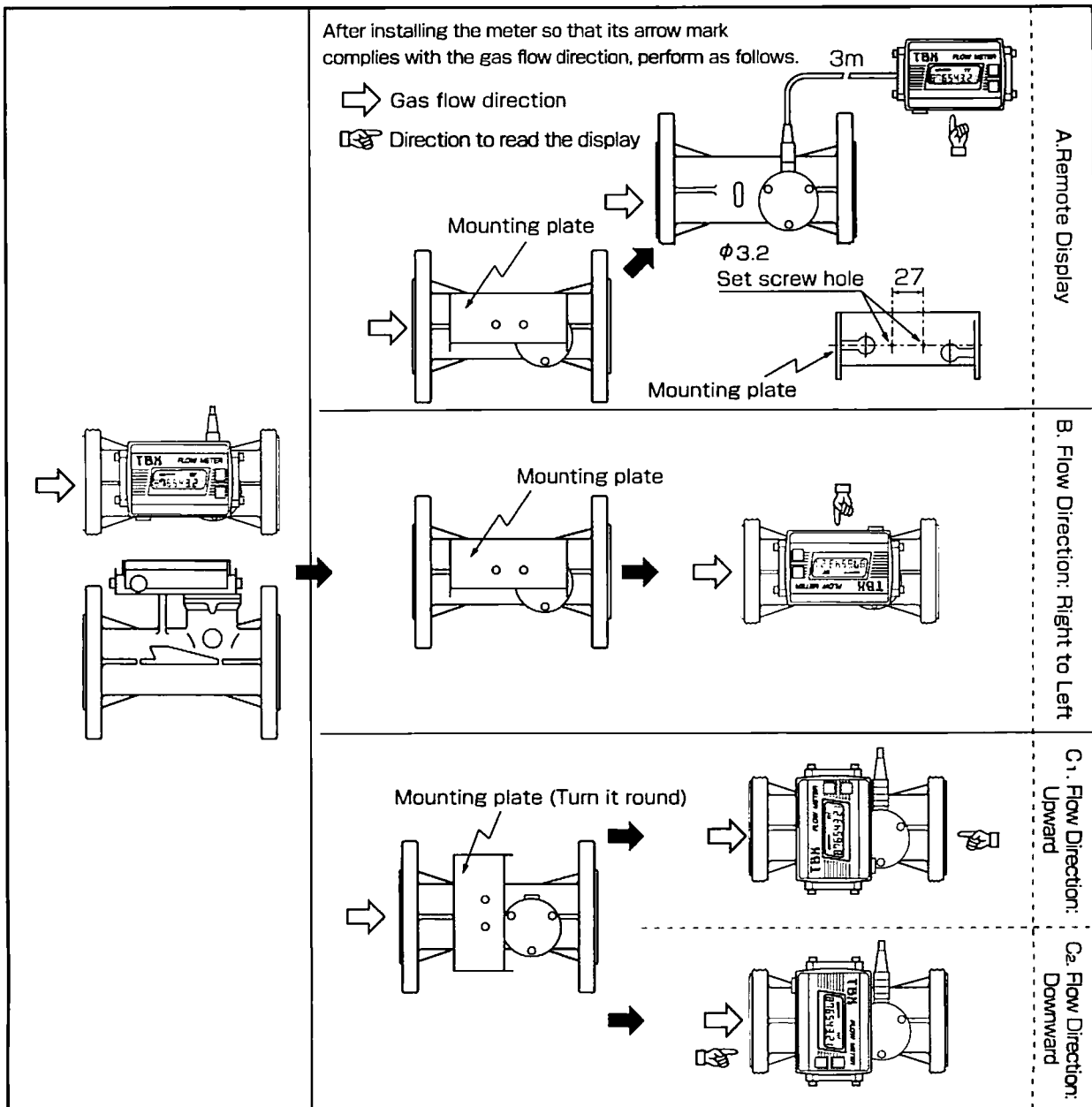

5. NAMES AND FUNCTION OF DISPLAY

1) For TBX30, TBX100, and TBX100F

- ③ Integrating flow volume indication (Total)
- ④ Instantaneous flow-rate indication
- ⑤ Integrating flow volume indication (Trip)
- *Select each indication with the related switch.
- ⑥ Pilot

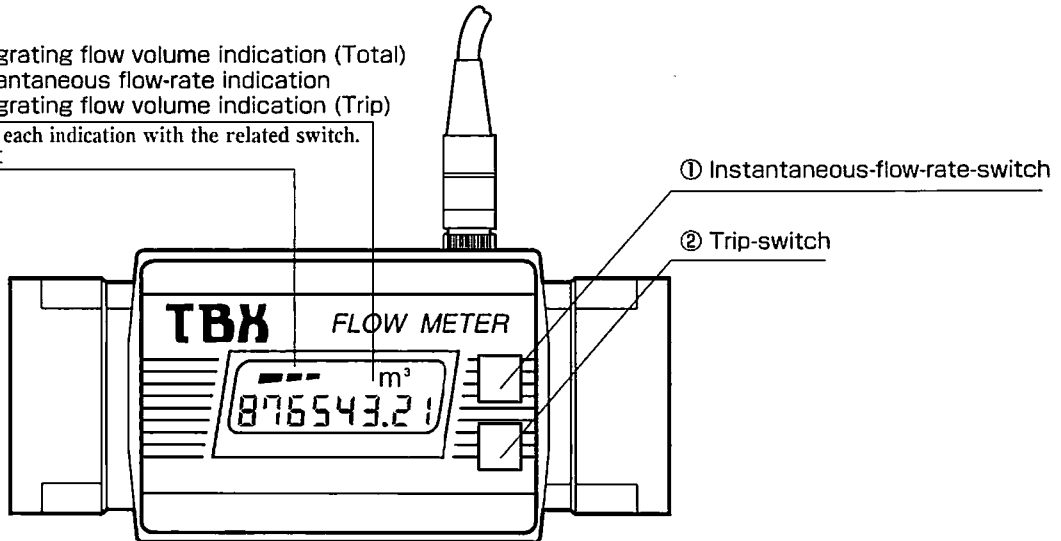

2) For TBX150F

- ⑥ Pilot
- ③ Integrating flow volume indication (Total)
- ④ Instantaneous flow-rate indication
- ⑤ Integrating flow volume indication (Trip)
- *Select each indication with the related switch.

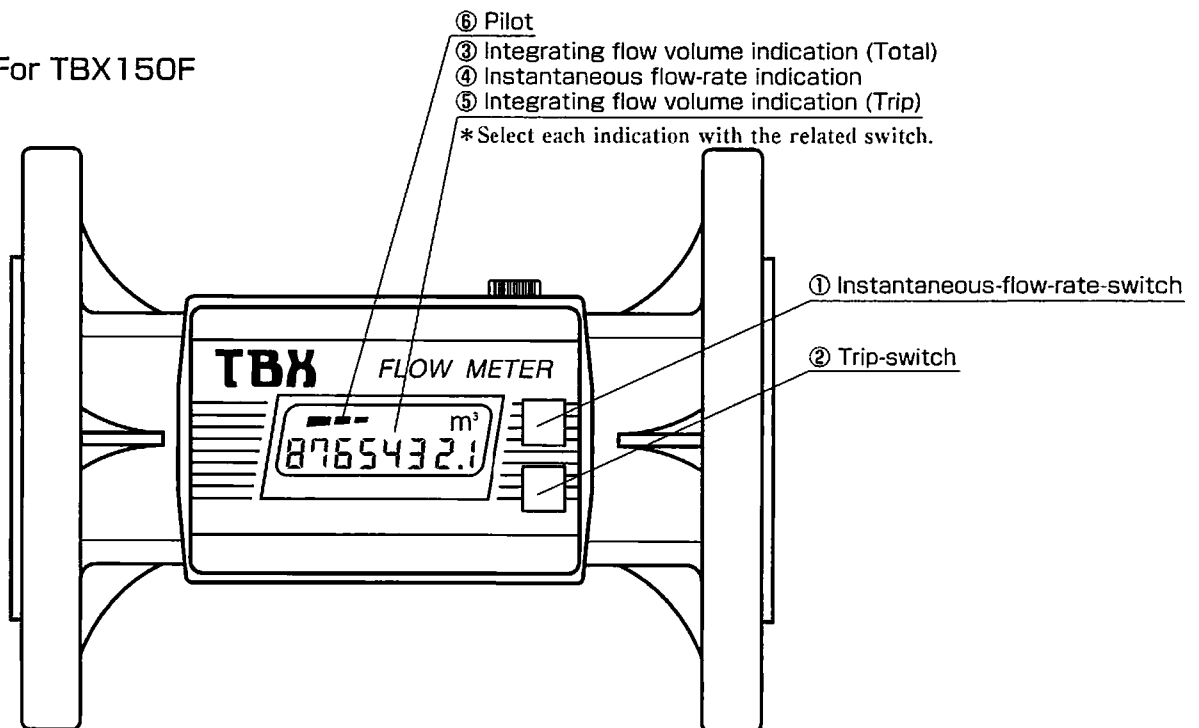

Portion	Model		TBX30	TBX100 TBX100F	TBX150F
	Description				
Switches	①	Instantaneous-flow-rate-switch	By pushing the switch, instantaneous flow-rate is indicated. After 30 seconds since, integrating flow volume (Total) is to be re-indicated automatically.		
	②	Trip-switch	By pushing the switch, integrating flow volume (Trip) from the moment counting from zero is indicated. By keep pushing the switch for 5 seconds, integrating flow volume (Total) is to be re-indicated.		
Display	③	Integrating flow volume (Total) indication (m ³)	999999.99 ^{m³}		999999.9 ^{m³}
	④	Instantaneous flow-rate indication (m ³ /h)	u 99.9 ^{m³} u	999.9 ^{m³} u	999
	⑤	Integrating flow volume (Total) indication (m ³)	9999.99 ^{m³}		99999.9 ^{m³}
	⑥	Pilot	 Flashing In case gas flows, it indicates the meter is under measuring.		



Caution

As pushing the switches strongly with something hard such as a knock pencil, a driver, etc., damages the switches, press them with something soft such as a fingertip.



Do Without Fail

At the time of shipment, the display is protected with the black rubber protector. Do not remove it until the completion of the installation work. In case the meter is to be used at unfavorable ambient environment, leave the protector to cover the display.

6. STARTING OPERATION PROCEDURE

1. Gradually open a valve at inlet side (at upstream of the meter).
2. Gradually open a valve at outlet side (at downstream of the meter).
Confirm flashing of the pilot.
3. Switch the indication of the meter to instantaneous flow-rate indication and set flow-rate to that of requirement with valve adjustment.
4. Switch the indication to the normal condition, which is integrating flow volume (Total) indication, and utilize the meter under the condition.

7. INSPECTION PROCEDURE



Caution

Rapid deterioration of the meter performance may happen depends on kind of gas to be measured, installation environment(s), and/or working condition(s).
Execution of periodical inspection suitable to your working conditions is necessary.

1. If the pilot of the display does not flash though gas flows, remove the meter from piping. Then, lightly breathe into the meter and check whether the pilot flashes. In case the pilot does not flash, check if there is any adherence of dust, etc., inside the meter and remove the same as occasion demands.
 - a. As for dust around the outer portion of the turbine rotor, there is possibility that giving the meter a slight shock removes the same. (As the meter is a precision measuring instrument, giving the meter a strong shock and hitting the meter with a thing are prohibited.)
 - b. If seal-material is adhered and removing the same is not possible at a worksite, send us the meter for repairing (The repairing shall be charged in principal).
2. After the removal of dust, etc., lightly breath into the meter again.
And, if the pilot flashes, it is the evidence of recovery to normal.
3. In case the meter does not recover to normal nevertheless the above-mentioned measures, please contact us.

8. SPECIFICATIONS

Model		TBX30	TBX100	TBX100F	TBX150F
Description					
Flow range (m ³ /h)		4~30	10~100	10~100	12.5~150
Max. Working Pressure (kPa)		100			
Accuracy		± 1%FS			
Display	Integrating (Total)	LCD 8 digits, Min. reading 10L			LCD 8 digits, Min. reading 0.1m ³
	Integrating (Trip)	LCD 6 digits, Min. reading 10L			LCD 6 digits, Min. reading 0.1m ³
	Instantaneous	LCD 3 digits, Min. reading 0.1m ³ /h	LCD 4 digits, Min. reading 0.1m ³ /h		LCD 3 digits, Min. reading 1m ³ /h
Gas flow direction (Selectable)		Left to right (L) Right to left (R)	Left to right (L) Right to left (R)	Left to right (L), Right to left (R) Upward, Downward	Left to right (L) Right to left (R)
Connection (Selectable for TBX30)		Rc 1 1/2 , Rc 1 1/4	Rc 2	2BFlange (JIS10K)	
Working temperature range (°C)		0~60			-10~60
Position of installation		Horizontal / vertical			
Kind of gas to be measured		City gas* ¹ , Natural gas* ¹ , LP gas* ¹ , air, nitrogen, etc.			
Power supply		Built-in lithium battery			
Output signal		Open collector output × 2 (Unit pulse, high density pulse)			
Place to be installed		Indoor			
Material		Aluminum alloy		Cast iron	Aluminum alloy
Weight (kg)		0.8	1.8	7.0	2.5

* 1 : As for measuring LP gas, city gas, or natural gas, please avoid installing the meter in a place where carbide substance (C5 or above) and/or dust powder, etc., waft.

9. DIMENSIONS

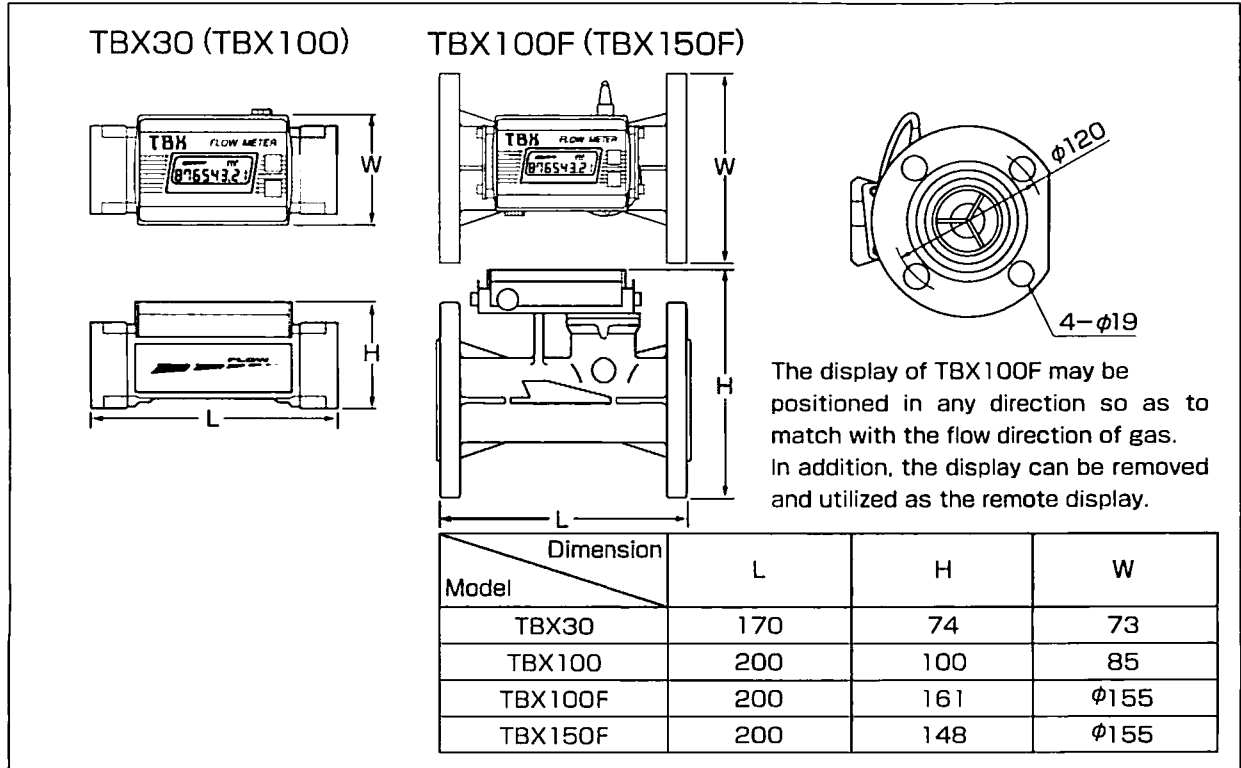

10. SERVICE LIFE

Description	Standard service life	Note
Main body of the Turbine Gas Meter	7 years	<p>In case of flow of oil mist and/or dust powder, etc., inside piping or of continuous long time use at flow-rate exceeding the maximum flow-rate, the service life is to be shorter.</p>
Lithium battery	7 years	<p>Continuous use at high temperature environment (60°C or higher) shorter the service life.</p>

11. APPLICATION EXAMPLES

The meter can be applied for flow managements / controls as follows.

- Management and control of gas flow of a combustion equipment such as a burner, a boiler, a furnace, etc.
- Management and control of gas flow of an intermediate and a compact size water-cooling and -heating equipment.
- Management and control of gas flow of a gas-refrigerator.
- Management and control of gas flow as one of the factory instrumentation.
- Management of factory air for each line and control of compressor running time (as power saving operation)
- Various experiment apparatus in which flow of gas is involved.

12. OUTPUT SIGNAL

This meter has 2-circuits of open collector output (*1).

For the output signals, utilize the exclusive signal wire unit (Model TBX-SS-B).

After fixing the solderless terminals (Accessory of the unit) to the signal wires, connect them to the terminal box.

Standard specification

Model	Unit pulse			High density pulse		Maximum impressed voltage
	Pulse unit	Pulse width	Maximum ON current	Pulse unit	Maximum ON current	
TBX30	0.01 $\frac{\text{m}^3}{\text{p}}$	40ms	20mA	Approx. 110 $\frac{\text{cm}^3}{\text{p}}$ *2	10mA	24V·DC
TBX100				Approx. 250 $\frac{\text{cm}^3}{\text{p}}$ *3		
TBX100F				Approx. 250 $\frac{\text{cm}^3}{\text{p}}$ *4		
TBX150F	0.10 $\frac{\text{m}^3}{\text{p}}$			Approx. 470 $\frac{\text{cm}^3}{\text{p}}$ *5		

*1: Unit pulse: Flow pulse which unit is settled to the certain pulse unit by the calculation circuit.

High density pulse: Actual flow pulse of which signal output synchronizes with rotation of the turbine rotor.

*2: The pulse unit has been modified from 56 $\frac{\text{cm}^3}{\text{p}}$ since July 1999.

*3: The pulse unit has been modified from 125 $\frac{\text{cm}^3}{\text{p}}$ since July 1999.

*4: The pulse unit has been modified from 125 $\frac{\text{cm}^3}{\text{p}}$ since July 2003.

*5: The pulse unit has been modified from 235 $\frac{\text{cm}^3}{\text{p}}$ since November 2000.

13. SIGNAL WIRE UNIT (OPTION)

TBX-SS-B

The signal wire unit is to connect the meter with a remote display, a counter, etc., which is consisted of 2m signal wire with the plug and the terminal box to replay signals.



Signal wire (2m) with plug

Connection method to utilize output signal

Kind of flow pulse	Unit pulse		High density pulse	
Color of signal wires	Red	Blue	White	Black
Polarity of terminals	+	-	+	-

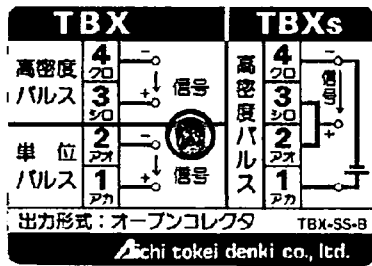

Terminal box (Outside)

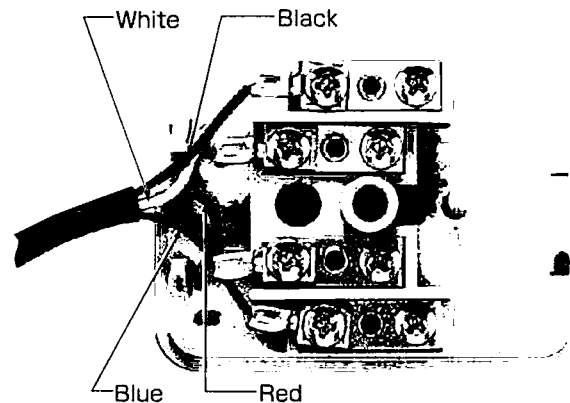

Terminal box (Inside)

Standard specification

Description	Specification
Plug	4 pins
Signal wire	Oil-resistant vinyl round-core wire 0.2mm ² × 4C
Terminal box (To replay signals)	For indoor communication wire, 4 terminals

14. REMOTE DISPLAY / COUNTER (OPTION)

Remote displays / counters and system example

1) Kind of Remote displays / counters

Model	Functions, etc.	Power supply
ZC09-96	Instantaneous flow indication, integrating flow indication, and pulse signal output	Built-in battery
ZX-562	Instantaneous flow indication, integrating flow indication, analog signal output, and alarm signal output	AC85V ~ AC264V
PM10Z	Integrating printer (with display)	AC100V
RE101	Recorder	Selectable from AC100V type, AC200V type, and DC24V type

2) System example

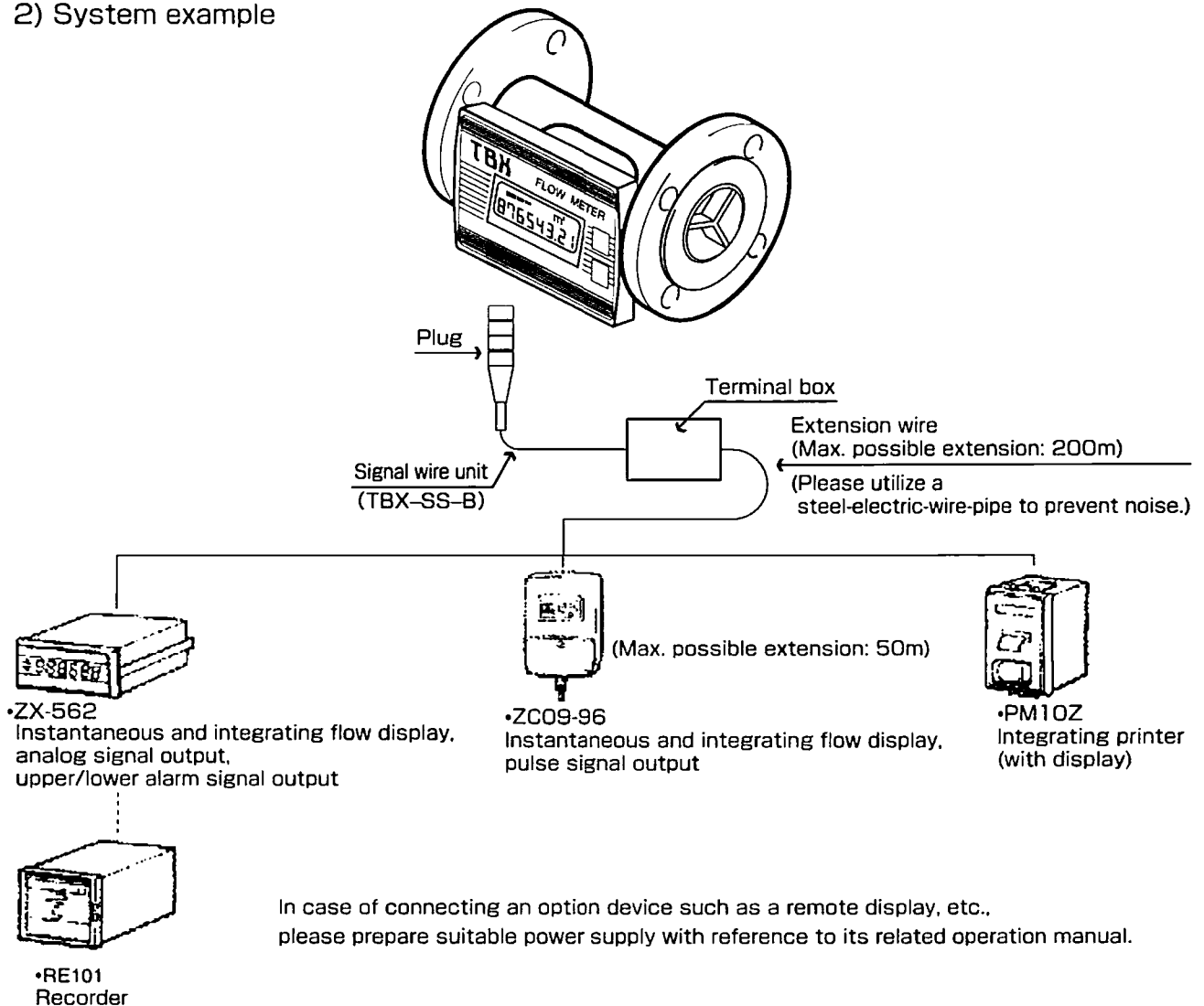

15. WARRANTY

1) Guarantee period

The turbine meter is guaranteed for a period of one year after shipment, against defect in manufacturing.

2) Guarantee scope

The turbine meter is guaranteed only against defects in materials and workmanship. Tokyo Gas Engineering assumes no responsibility for any damage incidental to the failure of the body and for any other failure caused by the following reasons.

- a. Force majeure such as an act of God.
- b. Improper handling.
- c. Use under improper working environment.
- d. Abuse beyond the limit of the rating specification, misuse, disassembly and modification made by any unauthorized person.
- e. Any others not attributable to Tokyo Gas Engineering.

Typical example

- Damage or defects caused by any foreign matter attracted by the built-in magnet, for example, iron particles.
- Damage or defects caused by foreign matter in piping.
- Damage or defects caused by stagnant water, oil, etc. in the body.